



## Short Description



- Stainless steel IP67, “S” type load cell
- Tension and compression applications
- Suitable for hanging, hopper and other weighing devices
- Also available in imperial capacities and dimensions



Test certificate no. D09-06.07  
C of C no R60/2000-CNI-06.02



Certificate no. 06-099A1

## Available Models

Capacity	Accuracy	Full article description
50kg	C3	B3G-C3-50kg-6B
100kg	C3	B3G-C3-100kg-6B
250kg	C3	B3G-C3-250kg-6B
500kg	C3	B3G-C3-500kg-6B
1t	C3	B3G-C3-1t-6B
2.5t	C3	B3G-C3-2.5t-6B
5t	C3	B3G-C3-5t-6B
7.5t	C3	B3G-C3-7.5t-6B
10t	C3	B3G-C3-10t-6B

Specifications and dimensions are subject to change without notice and do not constitute any liability whatsoever.

## Technical Specifications B3G

Accuracy Class		OIML R60 C3			
Output Sensitivity (= FS)	mV/V	3.0 ± 0.008			
Maximum Capacity ( E <sub>max</sub> )	t	0.05, 0.1	0.25, 0.5, 1, 2.5	5, 7.5, 10	
Max. Number of Load Cell Intervals	n <sub>LC</sub>	3000			
Ratio of min. LC Verification Interval	$Y = E_{max} / V_{min}$	7000	10000	12000	
Combined Error	%FS	≤± 0.020			
Creep Error (30 minutes)	%FS	≤± 0.016			
Temperature Effect on Zero (ZTC)	%FS/10°C	≤± 0.015			
Temperature Effect on Sensitivity (STC)	%FS/10°C	≤± 0.011			
Zero Balance	%FS	≤± 1.0			
Safe Overload	%FS	150			
Ultimate Overload	%FS	300			
Maximum Deflection	mm	0.1935 ~ 0.4079			
Excitation, Recommended Voltage	V	5 ~ 12			
Excitation, Maximum Voltage	V	18			
Input Resistance	Ω	430 ± 50			
Output Resistance	Ω	351 ± 2			
Insulation Resistance (50V)	MΩ	≥5000			
Compensated Temperature	°C	-10 ~ + 40			
Operating Temperature	°C	-35 ~ + 65			
Storage Temperature	°C	-40 ~ + 70			
Load Cell Weight	kg	0.05t – 1t: 0.5-0.8	2.5t-5t: ~1.5	7.5t: 3.1	10t: 5.6
Element Material		Stainless Steel			
Ingress Protection (acc. to EN 60529)		IP67			
Recommended Torque on Fixation Bolts	Nm	M8:25	M12:75	M20:450	M24:750 M30:1450
ATEX classification (optional)		II1G Ex ia II1C T4	II1D Ex iaD 20 T73°C	II3G Ex nL IIC T4	

## Wiring

### Features:

Cable type: Shielded, 4 conductor cable , conductor AWG 22  
 Cable diameter: Ø 5.0mm  
 Cable length: 6m  
 Cable jacket: Polyurethane  
 Shield not connected to element

### 4-Wire Connection Diagram

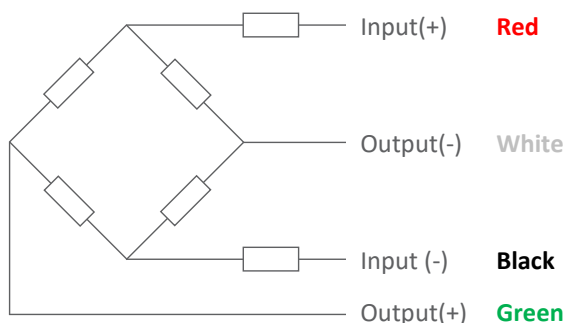

Specifications and dimensions are subject to change without notice and do not constitute any liability whatsoever.

## Dimensions in mm

Front View

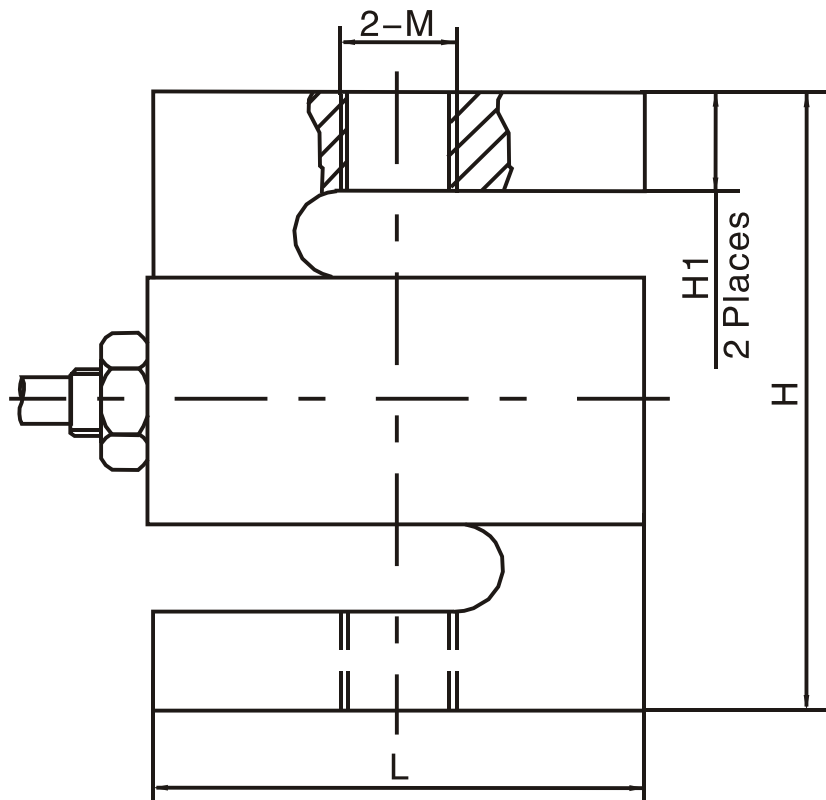

Side View

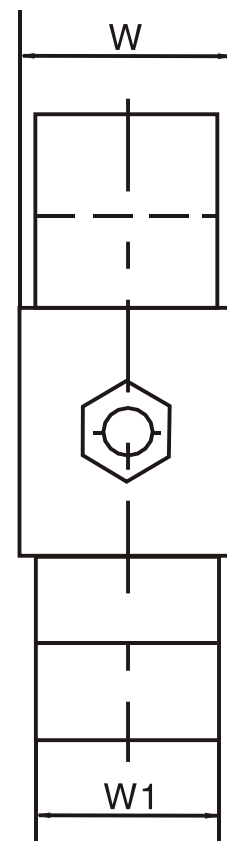

Dimension Capacity	L	H	H1	W1	W	M
50-100kg	50.8	60.96	8.89	11.68	15.06	M8
250-500kg	50.8	60.96	8.89	18.03	21.41	M12
1t	50.8	60.96	8.89	24.38	27.76	M12
2.5t	76.2	99.06	13.97	24.38	27.76	M20 x 1.5
5t	74.68	99.06	18.37	30.74	34.12	M20 x 1.5
7.5t	87.38	139.7	27.5	37.08	40.46	M24 x 2
10t	112.78	177.8	39.9	42.93	46.31	M30 x 2

## Available accessories

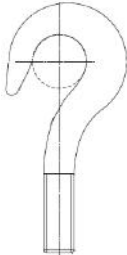
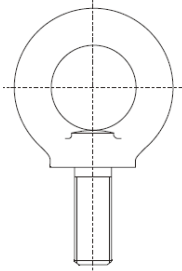
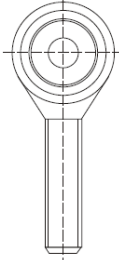
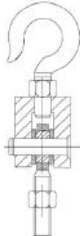
<p><b>HL-3-001-25kg-5t hook</b></p> <ul style="list-style-type: none"> <li>• Alloy Steel</li> <li>• Suitable for hybrid scales, crane scales, packaging scales and hopper scales</li> </ul>	
<p><b>HL-3-002-25kg-5t eye</b></p> <ul style="list-style-type: none"> <li>• Alloy Steel</li> <li>• Suitable for hybrid scales, crane scales, packaging scales and hopper scales</li> </ul>	
<p><b>HL-3-003-25kg-5t rod end</b></p> <ul style="list-style-type: none"> <li>• Alloy Steel</li> <li>• Suitable for hybrid scales, crane scales, packaging scales, hopper scales and other electronic weighing devices</li> </ul>	
<p><b>HL-3-004-25kg-5t hook assembly</b></p> <ul style="list-style-type: none"> <li>• Alloy Steel</li> <li>• Suitable for hybrid scales, crane scales, packaging scales, hopper scales and other electronic weighing devices</li> </ul>	
<p><b>HL-3-005-25kg-5t eye assembly</b></p> <ul style="list-style-type: none"> <li>• Alloy Steel</li> <li>• Suitable for hybrid scales, crane scales, packaging scales, hopper scales and other electronic weighing devices</li> </ul>	